



# Shine WebBox User Manual

# CONTENT

## 1 User Manual Information

- 1.1 Copyright Statement
- 1.2 About Manual
- 1.3 Target Group
- 1.4 Guideline

## 2 Production Description

- 2.1 Device Overview
- 2.2 Unpacking
- 2.3 Shine WebBox Network Introduction

## 3 Installation and Connection

- 3.1 Requirements for Installation Location
- 3.2 Shine WebBox Installation
- 3.3 Network Connection
- 3.4 Connection to PV System

## 4 Shine WebBox Integrated Server Function

- 4.1 Network Access via Integrated Server
- 4.2 Setting Shine WebBox via Integrated Server

## 5 Uploading Data to Shine Server

- 5.1 Registering and Logging in
- 5.2 Creating New Plant
- 5.3 Adding Shine WebBox
- 5.4 Visiting the Data from Shine WebBox

## 6 Uploading Data to the Shine Station

- 6.1 Installing the Shine Station
- 6.2 Logging in
- 6.3 Starting the Shine Station Monitoring
- 6.4 Checking Up the Data

## 7 Power Management

- 7.1 Active Power Reduction
- 7.2 Reactive Power Control
- 7.3 Manage Active and Reactive Power Simultaneously
- 7.4 PV Power Station Solution

## 8 Device Maintenance

- 8.1 Firmware Update
- 8.2 Stopping the Shine WebBox
- 8.3 Resetting the Shine WebBox
- 8.4 Clearing up the Record
- 8.5 Troubleshooting
- 8.6 Maintenance and Care

## 9 Technical Data

- 9.1 Shine WebBox
- 9.2 Plug-in Power Supply
- 9.3 Accessories

## 10 Contact

# 1 User Manual Information

## 1.1 Copyright Statement

Copyright © 2012 Shenzhen Growatt New Energy Co.,Ltd, hereinafter referred to as 'Growatt'. All right reserved. No part of this document may be reproduced, stored in a retrieval system, or transmitted, in any form or by any means, electronic, mechanical, photographic, magnetic or otherwise, without the prior written permission of Growatt New Energy. All infringement reserved.

Copyright No. is G1.0. Growatt reserved the final right of interpretation of this manual. The product parameters, appearances and packages are subject to change without notice. Readers are cautioned, however, that Growatt reserves the right to make changes without notice and shall not be responsible for any damages, including indirect, incidental or consequential damages, caused by reliance on the material presented.

## 1.2 About Manual

Distinguished users, thank you very much for your trust in our Shine WebBox product, which is developed and manufactured by our R&D department. We sincerely hope it can satisfy your need, also, we're glad to receive your suggestions on improving our product. The target of the manual is to provide the detailed product information, installation, operation and maintenance.

## 1.3 Target Group

The user manual is applied for technicians and common users to install, debug and maintain the Shine WebBox. The readers should be acquainted with some electrical knowledge, electrical schematic and characters of electrical components. The manual is not including the content of inverter, environment monitor, smart meter and anti-flux device. If needed, please refer to other user materials of our company.



## **1.4 Guideline**

Before using the Shine WebBox, please read the manual carefully. In the meantime, please keep it well, lest maintenance staff may not find it later. All the content, pictures, logos, symbols are reserved. No part of this document may be transmitted in any form without the prior written permission of our internal staff. The content of manual could be changed. Every attempt has been made to make this document complete, accurate and up-to-date. If there are any differences between the contents of the instruction and the product, please regard the actual one as the truth. You can download the newest version from our website [www.growatt.com](http://www.growatt.com) .

# 2 Production Description

## 2.1 Device Overview

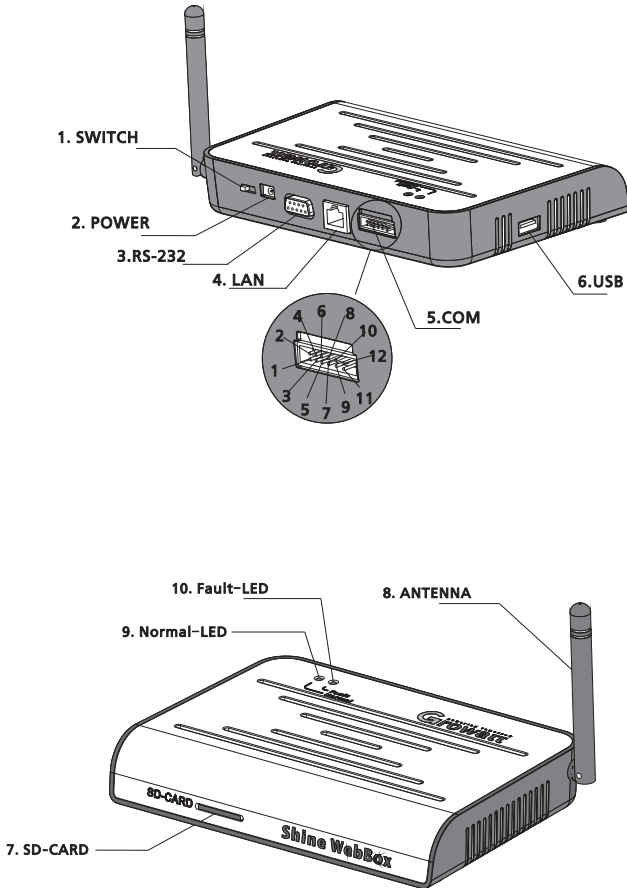

### 2.1.1 Interface

The description of Shine WebBox Interface is listed below.

<b>Label</b>	<b>Name</b>	<b>Function</b>
1	SWITCH	Power Switch: Turn On/Off Shine WebBox
2	Power Port	Power Line: Connect the power line to charge
4	LAN Port	RJ45 port: Connect Shine WebBox to the local network area of Shine Server through web line
5	COM Port	As to COM port, pin 2 and pin 4 are used for RS485; Others for active and reactive power adjustment
6	USB Port	Auto-update via U-disk
7	SD-CARD	Data storage via SD-CARD
8	ANTENNA	Receive wireless signal
9	NORMAL-LED	Green led, normal state
10	FAULT-LED	Red led, fault state.

### 2.1.2 Indicator Led

Indicator led can be divided into red led and green led.

Red led equals to fault-led, Green led equals to normal-led.

There are 6 different led color combinations which stand for different situations.

<b>Red led</b>	<b>Green led</b>	<b>Description</b>
Long lighting	Long lighting	System starting
Go out	Flash slowly	Searching inverters
Go out	Flash quickly	Some inverter is standing by
Go out	Long lighting	Inverters work normally
Long lighting	Go out	No SD card inserted
Long lighting with bummig	Go out	Inverters report error

## 2.2 Unpacking

### 2.2.1 Packing List

The Shine WebBox and accessories can be found as below.

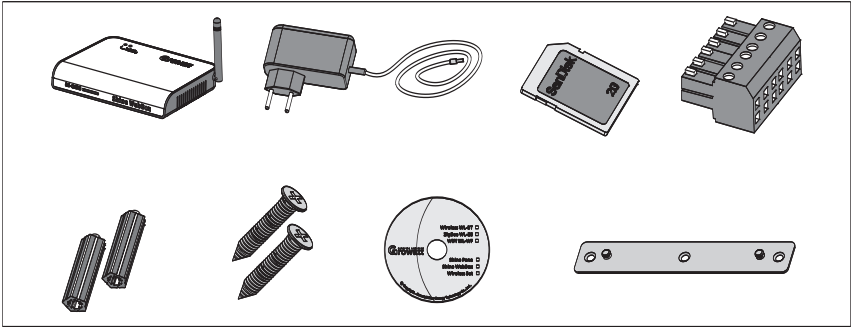

Label	Name	Amount
1	Shine WebBox	1pc
2	5V Power Adapter	1pc
3	2G SD Card	1pc
4	Terminal ( used for RS485 and ripple control receiver)	1pc
5	Plastic Column	2pcs
6	M3.5*20 Screw Spike	2pcs
7	Shine WebBox Instruction Disc	1pc
8	Bracket	1pc

### 2.2.2 Serial No.

The serial No. is ticked on the WebBox's packaging box, which have 10 digits mixed up with letters and numbers. All the serial No. are unique, to identify each WebBox. When you want to upload the data of WebBox to the server, you need the serial No. and 'check code' corresponding to the serial No. to register.

## 2.3 Shine WebBox Network Introduction

Shine WebBox can monitor the PV devices by RS485 or ZigBee.

Shine WebBox can make up a local area network by router or switching machine. You have local access by means of internal IP address. Otherwise, our WebBox can upload the data to our server and then you get remote access of the data throughout the realm name. Shine WebBox can communicate with inverters by RS485 or ZigBee, and keep the data into the internal RAM or SD card. We have access to the embedded server by visiting the internal IP address.

**Note:** The precondition of local access is that the address of PC and WebBox must be in the same segment, thereby building up a local monitoring system.

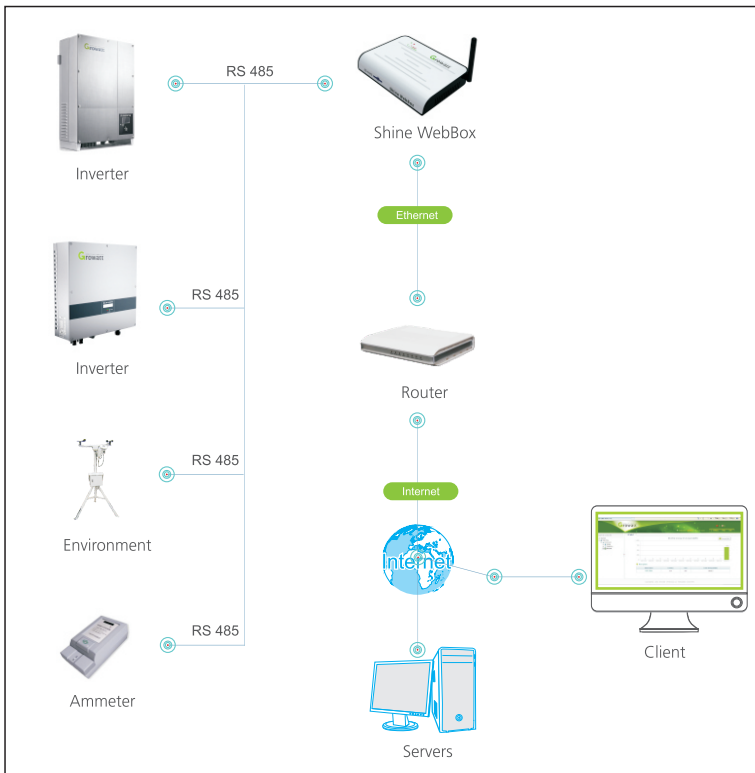

# 3 Installation and Connection

## 3.1 Requirements for Installation Location

The installation and operation environment and notification for communication:

- Indoor installation
- Temperature: from 0 – 45 degree (°C)
- Avoid humid environment
- Avoid being exposed to directly sun radiation
- The maximum cable length of RS485 communication bus is 1200m
- The maximum radius of ZigBee wireless communication is 300m (no obstacles)
- The maximum length of network cable used to connect switch or router is not more than 100m.

## 3.2 Shine WebBox Installation

### 3.2.1 Vertically Installation

Installation Procedure:

1. Install the bracket on the vertical plane of the wall. Dig two holes according to the dimension of the bracket, there are two screw holes. Use hammer or suitable tools to hit the plastic columns into the two hold on the wall. Use Philips screwdrivers to screw the screws into the columns to install the bracket firmly onto the wall.

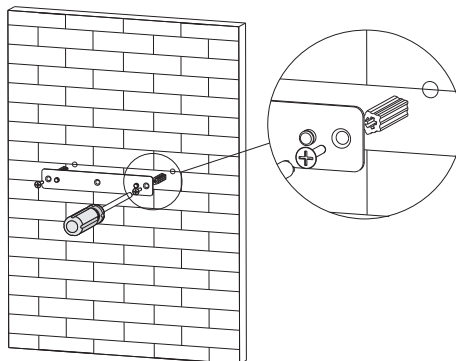

2. Hang Shine WebBox onto the bracket through the calabash ports in the back of Shine WebBox.

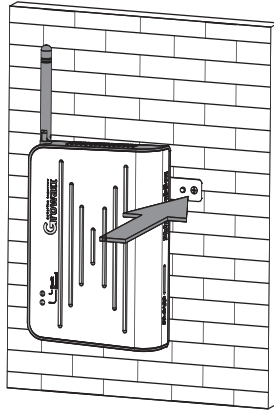

3. Finish the mounting of Shine WebBox, notice the clearance of mounting.

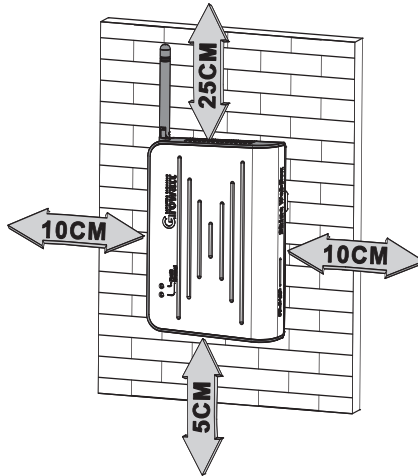

4. Connect the Shine WebBox and inverter using RS485 cables via the RS485 ports on them. Or Insert the ZigBee wireless module into RS232 port on inverter. Refer to ZigBee Wireless Module User Manual.

5. Connect the network cable: insert the network connector to the LAN port on Shine WebBox.

6. Insert the SD card: Insert the SD card into the SD card port on Shine WebBox, notice that SD card must be inserted before powering on Shine WebBox or the SD card would not be recognized.
7. Connect the power line: connect the power line to the power port on Shine WebBox.
8. Turn on the power switch to power on Shine WebBox.

## 3.2 Horizontally Installation

Installation Procedure:

1. Set Shine WebBox on a horizontal plane.

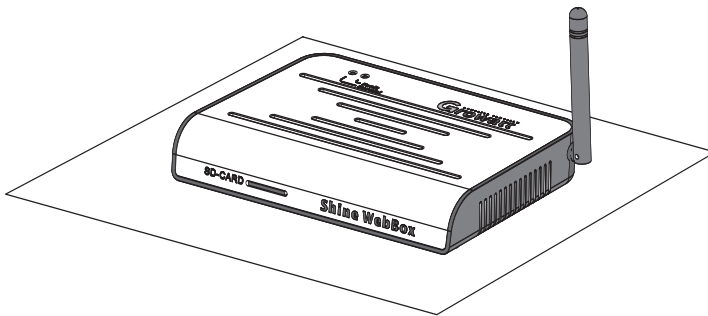

2. As to the rest steps, please refer to aforementioned step 4-8 in chapter 3.2.1.

## 3.3 Network Connection

### 3.3.1 Setting IP Address of PC

The default network configuration is listed as below.

IP address: 192.168.1.230

Subnet mask: 255.255.255.0

Default gateway: 192.168.1.1



**Note:** Only the IP addresses of the Shine WebBox and the accessing PC are in the same network segment, then it's available to get access into the integrated server of Shine WebBox.

## 1. Window XP OS

Click to open the program "Network" → open "Local Connection" → choose "Internet Protocol version 4 (TCP/IPv4)" → double click to open "Internet Protocol TCP/IP Properties" → "Use the following IP address", set the IP address of the PC and Shine WebBox to be the same network segment. Set the IP address of PC referring to following pictures:

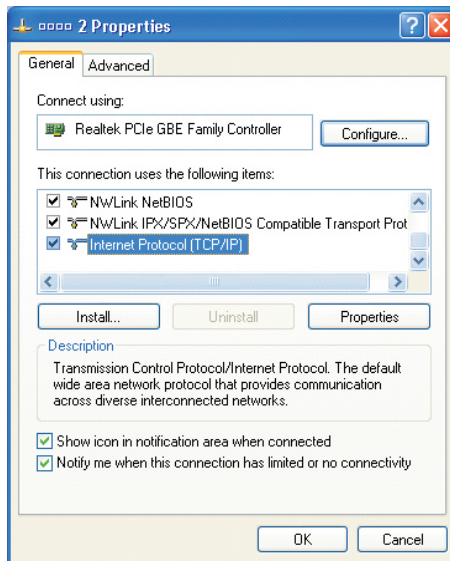

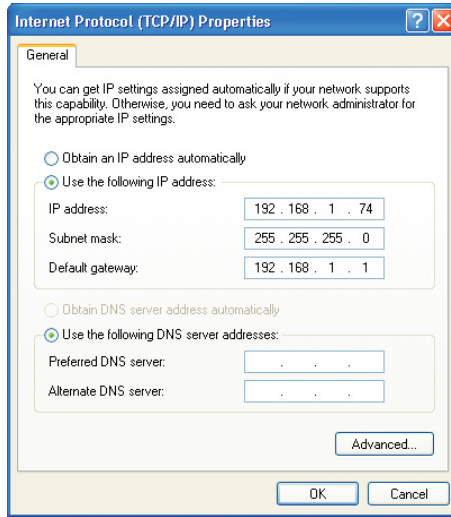

## 2. Windows 7 OS

Click to open “Network” → “Connection to a network” → “Local Connection” → “Internet Protocol version 4 (TCP/IPv4)”, change the IP address of the PC and Shine WebBox to be the same network segment.

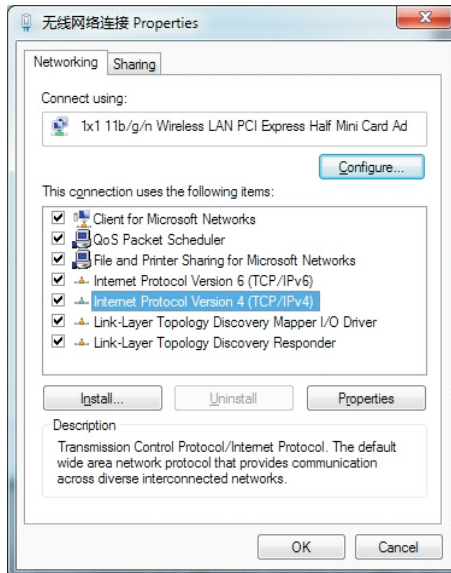

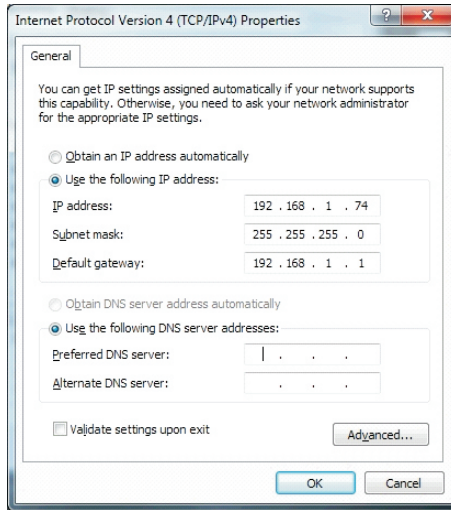

### 3.3.2 Directly Connect to the PC

1. Power on the Shine WebBox and connect to the PC via network cables, the RJ45 ports on Shine WebBox.

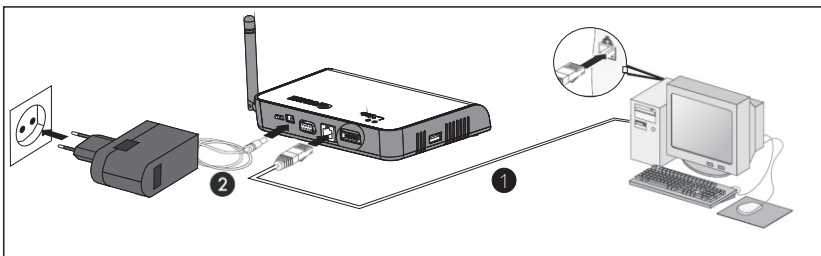

2. Set the IP address, default gateway. Please confirm the IP address of the PC and Shine WebBox to be the same network segment.

### 3.3.3 Connection via Network Router

1. Set the gateway of the router to be 192.168.1.1, if don't know how to configure please contact your network manager.
2. Connect the PC and Shine WebBox through the network ports of router to make them work in the same local area network.

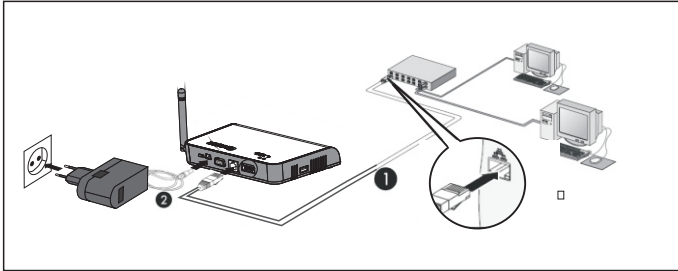

3. Check the IP address and gateway of the PC to confirm that the PC connected to router and Shine WebBox are in same network segment.

### 3.3.4 Connection via Network Switch

1. Connect the PC and Shine WebBox to the network ports of network switch.
2. Set the IP address of the PC and Shine WebBox to be in the same segment.
3. Power on the PC, Shine WebBox and network switch then it's available to get access to Shine WebBox on the PC.

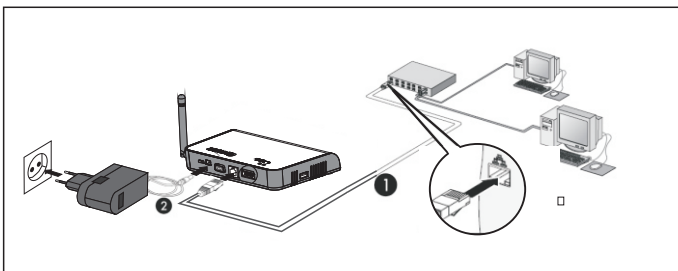

## 3.4 Connection to PV System

Shine WebBox can monitor devices in PV system such as the inverter, environmental monitor and smart meters etc.

### 3.4.1 RS485 Communication

1. PV devices are connected to Shine WebBox via RS485 cable connection. Note that Pin 1 of RS485 is corresponded to Pin 4 of Shine WebBox Com port; while Pin 2 of RS485 is corresponded to Pin 2 of Shine WebBox COM port.

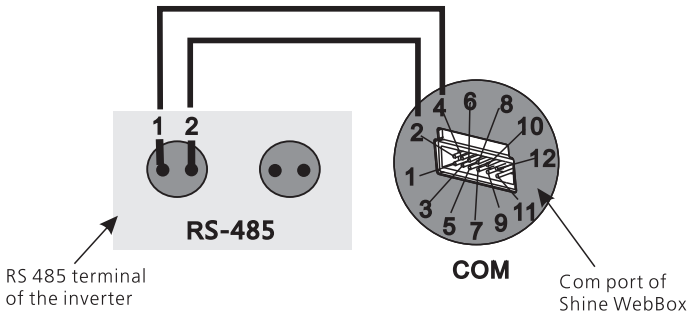

2. While monitoring several inverters, inverters are series connected to Shine WebBox. The maximum number of series monitored inverter for Shine WebBox simultaneously is 30 units.

3. The monitoring to smart meter and environmental monitor is similar to monitoring inverter. Cascade the environmental monitor to the inverter and connect the smart meter to Shine WebBox directly via the communication cables.

**Note:** Currently the Shine WebBox can monitor only the indicated brand and models smart meters and ambient sensors.

### 3.4.2 ZigBee Wireless Communication

Insert the ZigBee Module into inverter communication port and build the wireless communication to Shine WebBox, before monitoring please make settings according to the user manual of ZigBee wireless modules (which is packaged together with ZigBee), such as indicating the ZigBee ID and channels in Shine WebBox.

# 4 Shine WebBox Integrated Server Function

## 4.1 Network Access via Integrated Server

In order to get access to integrated server of the Shine WebBox, please confirm the wiring of devices is OK and the setting of IP address is correct. After that, start the web browser and enter 192.168.1.230 in the address bar. To enable the access to integrated server, the IP address of PC and Shine WebBox must be in the same segment.

**Note:** when WebBox connects to local network, please confirm the IP address 192.168.1.230 is not occupied by other device. Otherwise the IP addresses will conflict.

1. The main interface of integrated server is shown as below.

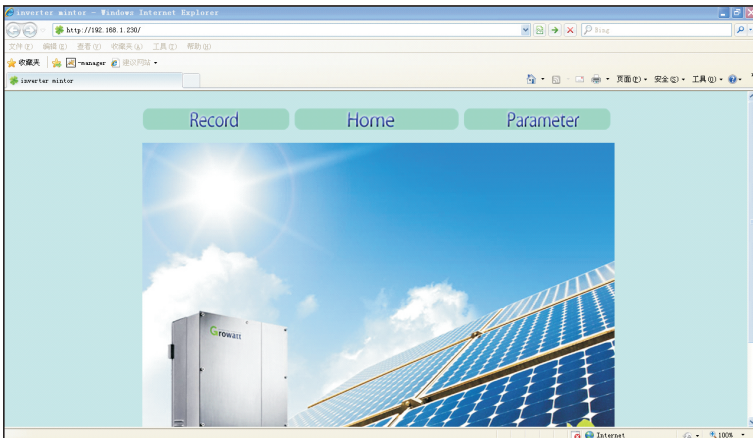



## 4.2 Setting Shine WebBox via Integrated Server

### 4.2.1 System Configuration

#### 4.2.1.1 Setting IP Address of the Shine WebBox

The address setting includes IP address, subnet mask, default gateway. If first, second, and third numbers of IP address which the Shine WebBox employs coincide with that of default gateway, the IP address of Shine WebBox just need to be configured rather than setting the subnet mask, default gateway and DNS.

Local_ip:	<input type="text" value="192.168.1.230"/>
Mask:	<input type="text" value="255.255.255.0"/>
Gateway:	<input type="text" value="192.168.1.1"/>
DNS:	<input type="text" value="192.168.1.1"/>

1. You are able to operate the Shine WebBox by using integrated web browser in the local network. Click on "parameter" to go to the setting page.
2. Select "local\_ip", enter the fixed IP number if you want to change the IP address, for example the default address is 192.168.1.230, and you can change it to 192.168.1.240 referring to following picture.

Local_ip:	<input type="text" value="192.168.1.240"/>
-----------	--

3. The subnet mask of the Shine WebBox and that of the network which Shine WebBox accesses should be same.
4. Set the default gateway of the Shine WebBox same as that of the router which WebBox connects to. Please confirm the default gateway is compliant with the network.



5. Normally DNS is equal to the default gateway. Also you can set the DNS same as the network.

6. After configuration, click on “save” at the bottom. After setting the IP address successfully, restart the Shine WebBox, then you can get access to the WebBox using web browser by entering the new IP address.

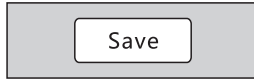

#### 4.2.1.2 Setting IP Address of the Server

The IP address of the server could be regarded as the IP address of Shine Server which is one of the products of Growatt. Normally Shine WebBox gets access to server according to the IP address; otherwise it will detect the server according to the domain name. The default IP address of integrated server in Shine WebBox is 192.168.1.74

1. In “parameter” field, select “server\_ip”, enter the IP address of Shine Server. For example change the IP address of server from 192.168.1.74 to 223.4.29.219.

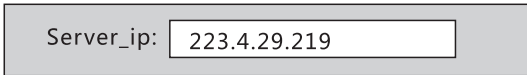

2. Click on “save”, the configuration has been carried out successfully; Shine WebBox could upload the data to specified server.

#### 4.2.1.3 Setting Domain Name of the Shine Server

In “parameter” field, select “server\_url”, enter the domain name of the server. The default domain name is “http://server.growatt.com”, if the domain name filled in the integrated server of the Shine WebBox does not coincide with the default one, please change the domain name to the default setting ‘http://server.growatt.com’ , ensuring Shine WebBox could upload data to Shine Server.

#### 4.2.1.4 Setting Initial and Final Address

1. In “parameter” field, under “Addren\_star”, default initial address is 1, and under “Addren\_end”, default final address is 32. The initial address could be changed within the range up to final address. All the inverters under monitoring should be in the range between initial address and final address, otherwise, the inverters out of range could not be monitored normally.

Addren_start:	<input type="text" value="1"/>
Addren_end:	<input type="text" value="32"/>

2. Click on “save”, configuration has been carried out successfully.

#### 4.2.1.5 Setting ZigBee

1. Setting ID for ZigBee, in “parameter” field, select “ZigBee\_ID”, enter ZigBee ID within the range between 1000 and 9999.

2. Setting channel for ZigBee, in “parameter” field, select “ZigBee\_channel”, enter the ZigBee channel within the range between 11 and 25.

3. If the parameters about ZigBee have been modified in the web browser accessing to the Shine WebBox, the configuration of ZigBee module connecting to the inverter also needs to be modified. As to detailed information, please refer to ZigBee module user manual.

#### 4.2.1.6 Setting Environmental Monitor and Smart-meter

The Shine WebBox currently supports the data exchange with environmental monitor and smart-meter; you can activate this function by using the web browser in the local network.

1. In "parameter" field, select "environment:addrn", choose "ON", then click on "save". After that, Shine WebBox could operate environmental monitor. The address of the environmental monitor is 36, which should not be modified. Please set the address of environmental monitor to 36 in its own LCD interface, and select "Modbus" protocol.

2. In "parameter" field, select "Ammeter:addrn", choose "ON", then click on "save". After that, the communication between smart-meter and Shine WebBox has been set up.

Environment:addrn	<input type="text" value="36"/>	ON <input type="button" value="v"/>
Ammeter:addrn	<input type="text" value="37"/>	ON <input type="button" value="v"/>

**Note:** the manufactures of environmental monitor and smart-meter have been specified by Growatt, ensuring to communicate well.

#### 4.2.2 Setting Data and Time

In "parameter" field, select "enable\_write" → Enter the data and time → "Save".

System_time:	<input type="text" value="2013-01-09 10:36:52"/>	<input checked="" type="checkbox"/> Enable_write
--------------	--	--

#### 4.2.3 Data Update Frequency

1. In "parameter" field, you can choose the data updating frequency from the drop-down list. The default setting is 2s. For example, set the updating frequency to 1.5s.

Delay time ( S ) :	<input type="text" value="1.5"/>	<input type="button" value="v"/>
--------------------	----------------------------------	----------------------------------

2. Click on "save". The configuration is OK.

#### 4.2.4 Setting Power Management

In “parameter” field, select “power Adjust”, choose “ON”. In a local network, only one Shine WebBox can be chosen as host, the others should be set as slave.



The image shows a horizontal control panel with a light gray background. On the left, the text "Power Adjust:" is followed by a white rectangular button containing the text "ON" and a small downward-pointing arrow icon. To the right of this is a larger gray rectangular area. On the far right of this area is another white rectangular button containing the text "Host" and a small downward-pointing arrow icon.

#### 4.2.5 Fault Indication

There are two ways to indicate the inverter fault:

1. The status LED of the Shine WebBox will turn to red, accompanying with beeping for 1 min.
2. In the integrated server interface of the Shine WebBox, the data about the inverters are shown in red.

# 5 Uploading Data to Shine Server

Shine WebBox does not only provide monitoring locally, remote monitoring method is also available via Shine Server. The Shine WebBox will upload the status and data of the inverters to the Shine Server. You can visit the historical data, real-time data, historical chart and real-time chart from the interface of the Shine Server.

## 5.1 Registering and Logging in

1. Start the web browser, and enter <http://server.growatt.com> in the address bar. If you are the first time to login, please make a registration in advance.



2. Fill in the related information and click "submit" to finish the registration.

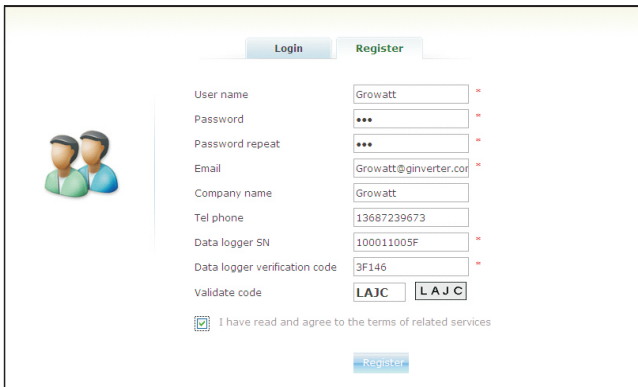

## 5.2 Creating New Plant

1. After registering successfully, it will redirect to the Shine Server Home page automatically.

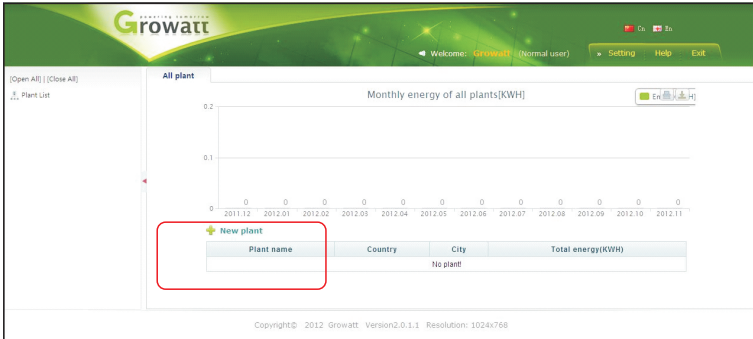

2. Click on "New Plant", and you will turn to the "new plant" page below.

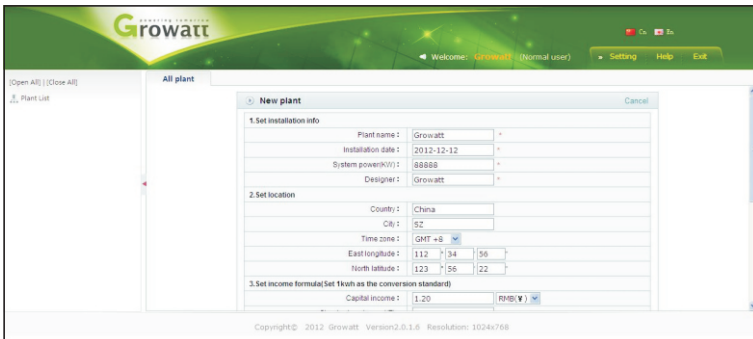

3. Fill in the plant information and click “submit”. It will redirect to the “Plant list” on the home page, which means we have finished the “new plant” work.



### 5.3 Adding Shine WebBox

Adding the Shine WebBox to make it connected to Shine Server.

1. Click “Setting” → Select “Devices Management”.

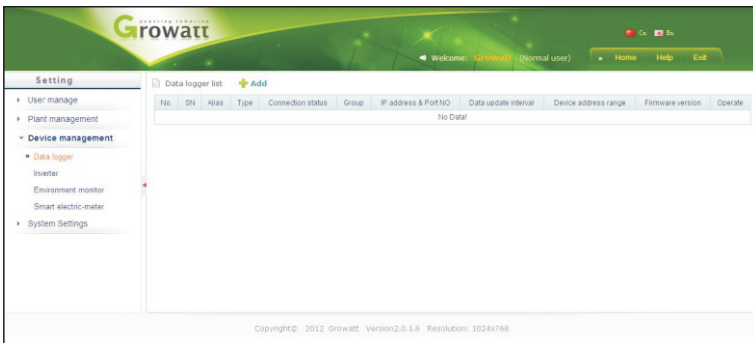

2. Click "Data Logger" and add the Shine WebBox.

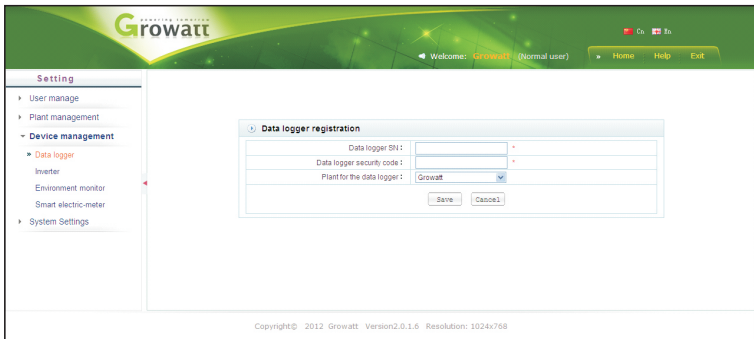

3. Fill in the information of Data Logger "Serial Number" and "validate code". After choosing the plant type, click "summit" to finish all the work.

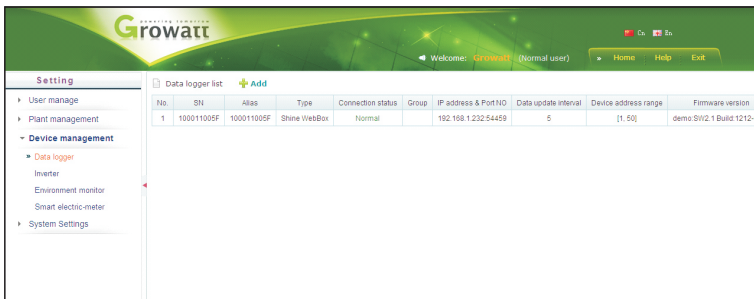



## 5.4 Visiting the Data from Shine WebBox

1. Click “inverter” under the list of plant list, the overview of inverters is below.

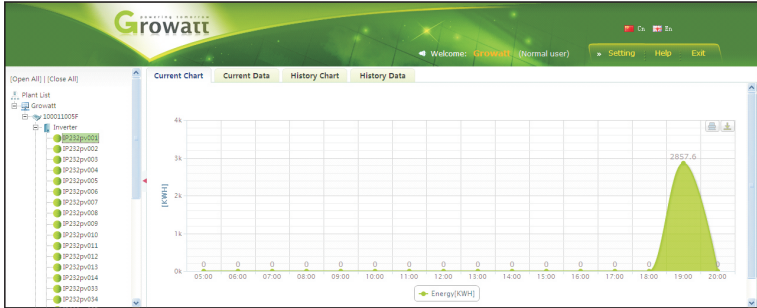

2. Click the real-time chart, real-time data, historical chart and historical data on the left to view the whole data.

The screenshot shows the Growatt Shine WebBox interface with the 'History Data' tab selected. The table displays the following data:

No.	Time	Status	Vp1(V)	Ip1(A)	Pp1(W)	Vp2(V)	Ip2(A)	Pp2(W)	Vp3(V)	Ip3(A)	Pp3(W)	Va1(RV)	Va2(SV)	Va3(TV)	Ia1(RA)	Ia2(SA)	Ia3(TA)	FacPH
1	2012-12-24 19:13:39	Normal	248.1	0.0	0.0	0.0	0.0	0.0	0.0	0.0	0.0	224.8	0.0	0.0	12.7	0.0	0.0	50.02

# 6 Uploading Data to the Shine Station

The monitoring data in the Shine WebBox could be viewed via the Shine Station.

## 6.1 Installing the Shine Station

The installation procedure is brief. Just double click the installer, and carry out the operation according to the prompt.

## 6.2 Logging in

After installation, a shortcut icon of the Shine Station will be set up on the desktop. Double click the shortcut icon, and a new small icon of the Shine Station will appear in the bottom right corner of the desktop.



Right click the small icon, and select the "Start server". After a while, the prompt information will pop up.

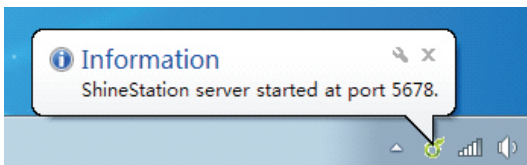

Start web browser (Google Chrome is recommended), enter the native IP address and port number 5678, e.g. the native IP address of the server or computer installed with Shine Station is 192.168.1.74, then enter 192.168.1.74:5678 or 127.0.0.1:5678 in the web browser.

The operation of the Shine Station could be carried out after logging in. The user name defaults to admin. And password is 123456.

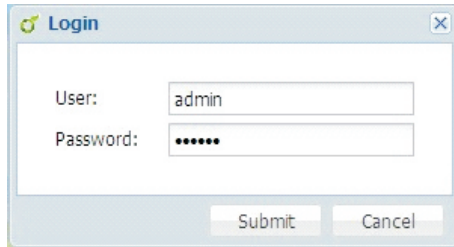

### 6.3 Starting the Shine Station Monitoring

Click on "Search Device", select "TCP Setting" from the drop-down list.

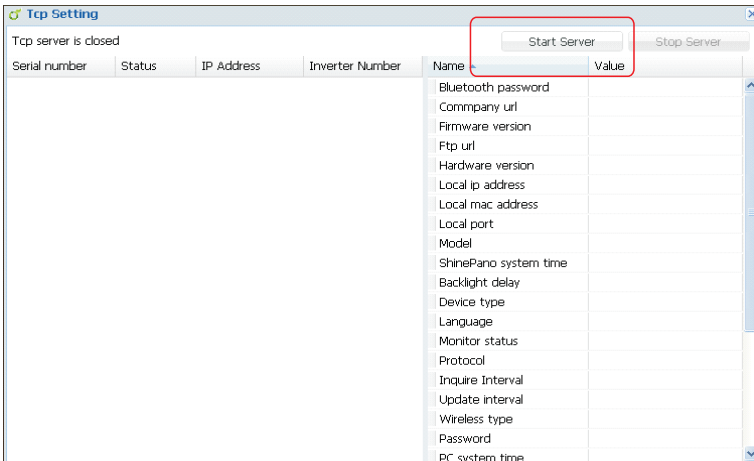

Click on “Start Server”, enable the monitoring service. When the Shine WebBox is connected to the Shine station well, the setting status will display as below.

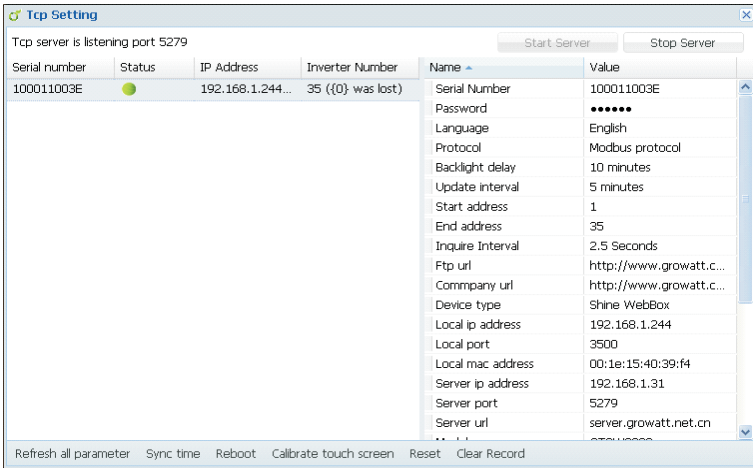

## 6.4 Checking Up the Data

When Shine WebBox connects to the Shine Station well, the plant status could be viewed via the Shine Station.

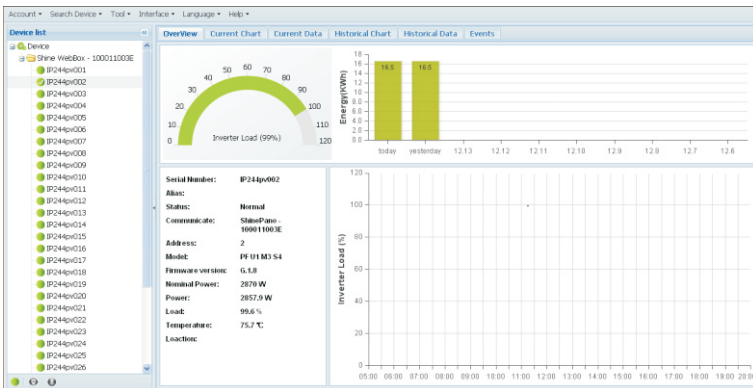

# 7 Power Management

Shine WebBox power management is composed of active power reduction and reactive power control components. To enable power management, a ripple control receive is required. This function is available when user activates it. The COM ports of the Shine WebBox are shown as below. Pin 1,3,5,7,9,11 are used to connect the ripple control receiver.

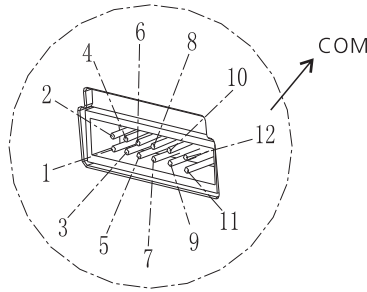

## 7.1 Active Power Reduction

There are 4 power levels, 100%, 60%, 30% and 0%. The connection between ripple control receiver and Shine WebBox is shown as below.

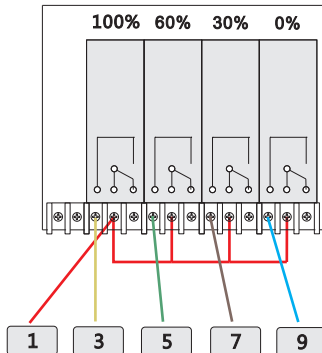

The output power of inverter depends on the operating relay. The detailed information is shown as below. Pin 1 is connected to 3.3V dc source.

Pin	Status	Explanation
1	3.3V DC source	Powering relays
3	100% output power	When the relay corresponding to pin 3 actions, the inverter outputs 100% of nominal power.
5	60% output power	When the relay corresponding to pin 5 actions, the inverter outputs 60% of nominal power.
7	30% output power	When the relay corresponding to pin 7 actions, the inverter outputs 30% of nominal power.
9	0% output power	When the relay corresponding to pin 3 actions, the inverter outputs 0% of nominal power.

## 7.2 Reactive Power Control

There are 4 power factor levels, 0.99, 0.98, 0.97, and 0.95. The connection between ripple control receiver and Shine WebBox is shown as below.

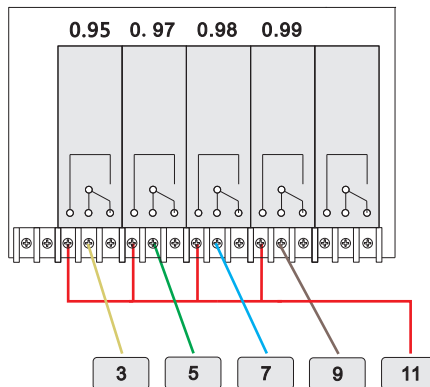

The output reactive power of inverter depends on the operating relay. The detailed information is shown as below. Pin 11 is connected to 3.3V dc source.

Pin	Status	Explanation
9	0.99 PF	When the relay corresponding to pin 9 actions, the power factor of the output power is 0.99
7	0.98 PF	When the relay corresponding to pin 9 actions, the power factor of the output power is 0.98
5	0.97 PF	When the relay corresponding to pin 7 actions, the power factor of the output power is 0.97
3	0.95 PF	When the relay corresponding to pin 9 actions, the power factor of the output power is 0.95

### 7.3 Manage Active and Reactive Power Simultaneously

If active power and reactive power need to be managed at the same time, connect the Shine WebBox with two ripple control receivers as below.

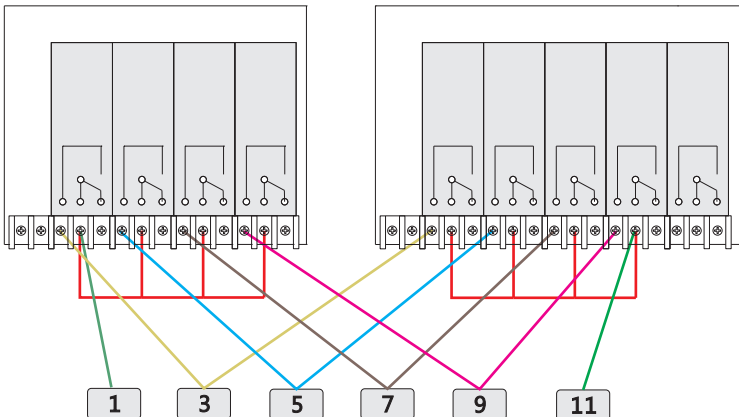

## 7.4 PV Power Station Solution

In PV power station, there are more than one WebBox. You can choose one WebBox as the host and connect it to the ripple control receiver. The host WebBox could send commands to other WebBoxes (slave WebBox) by the local network.

Normally, the ripple control receiver would send commands to the host WebBox if power management is required. The host WebBox would operate the inverters connected to it; meanwhile, it would send commands to slave WebBoxes, which could operate other inverters.

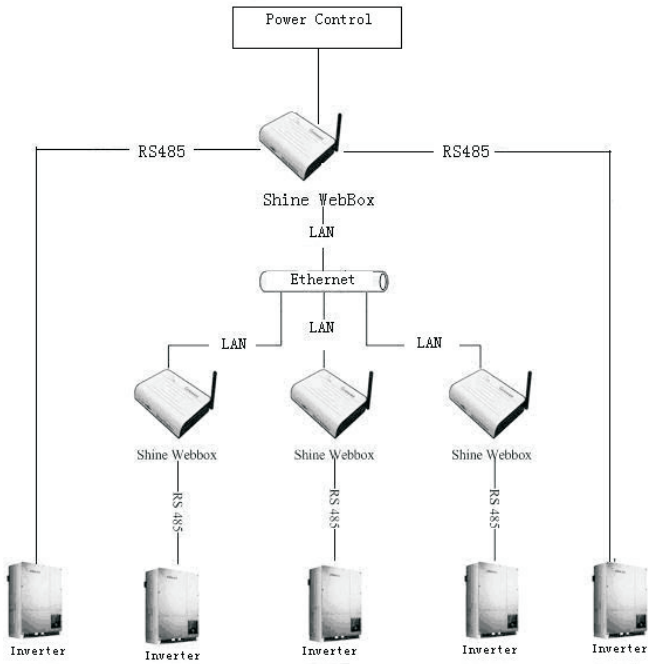



# 8 Device Maintenance

## 8.1 Firmware Update

You can update WebBox firmware by using U disk or SD card.

1. Copy the required update file to the root directory of U disk or SD card.
2. Plug the U disk into WebBox USB interface.

When WebBox sounds twice, the firmware update is carried out successfully. 3-5 seconds later, pull out the U disk. You can check up the firmware version by integrated server of WebBox after restarting the WebBox. If WebBox sounds 3 times, it indicates a failure operation, you can update the WebBox again after have restarted it and waited for 1 min.

## 8.2 Stopping the Shine WebBox

You can stop the Shine WebBox by turning off power switch.

## 8.3 Resetting the Shine WebBox

The integrated user interface is required in the local network when resetting the shine WebBox.

1. In "parameter" field, select "Enable\_Reset".

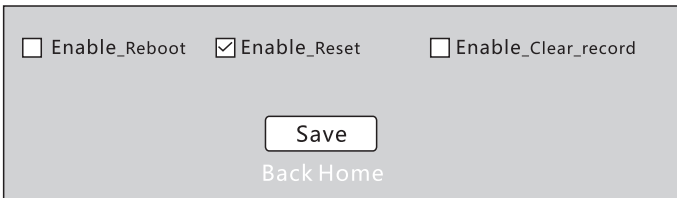

The screenshot shows a configuration panel with three checkboxes: 'Enable\_Reboot' (unchecked), 'Enable\_Reset' (checked), and 'Enable\_Clear\_record' (unchecked). Below the checkboxes is a 'Save' button and a 'Back Home' link.

2. Click on "save". The Shine WebBox would restore factory settings after restarts.

## 8.4 Clearing up the Record

1. In “parameter” field, select “Enable\_Clear\_record”.

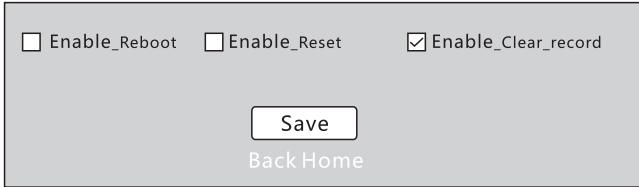

The screenshot shows a configuration panel with three checkboxes:  Enable\_Reboot,  Enable\_Reset, and  Enable\_Clear\_record. Below the checkboxes is a  button and a [Back Home](#) link.

2. Click on “save”, all the records would be wiped out after the Shine WebBox restarts.

## 8.5 Troubleshooting

Problem	Cause	Rectification
The Shine WebBox is not available.	The address of inverter is not fixed	Reset inverter address to fixed one and ensure all the inverters connecting to the same WebBox have the exclusive address
Local network is not available	Shine WebBox and the connecting PC are not in a same network segment	Make sure the WebBox and PC are in the same network segment. If the problem still exists, please contact the network administrator.
Web server is not available	The web server is not connected to Internet	Make sure web server is connected to Internet and the domain name of the server is correct.
WebBox does not upload data to server	The default IP address of server is occupied by other computer in the local network	Reset the IP address of server to the static address (see section 10.1.2), or please contact the network administrator

## 8.6 Maintenance and Care

1. Conduct regular visual inspections of the Shine WebBox to check for external damage or dirt. Please avoid switching power frequently.
2. Shine WebBox is only adapted to indoor environment. Protect WebBox from wet conditions and direct sunlight. To clean the Shine WebBox, only use a lightly dampened cloth to prevent the penetration of moisture.

# 9 Technical Data

## 9.1 Shine WebBox

### Mechanical data

---

Width*height*depth	185mm* 125mm * 30mm
Net weight	420g

### Environmental conditions

---

Ambient temperature	0 °C ... 45°C
Degree of protection	IP 20
Mounting location	Indoor

### Communication

---

Rs485 communication	Maximum 30 inverters
Wireless communication	ZigBee,maximum 15 inverters
Rs485 communication range	1200m,STP
ZigBee communication range	300m,obstruction free

## 9.2 Plug-in Power Supply

### Power supply

---

Input	100~240V 50/60Hz
Output	5Vdc,2000mA

## 9.3 Accessories

### 9.3.1 SD Card

The SD card with 2GB of memory used in the Shine WebBox could be valid for 5 years.

### 9.3.2 RS485 Cable

To ensure the stable communication between the Shine WebBox and inverters, the RS485 cable that consists of STP (shielded twisted pair) is preferred. The maximum cable length of RS485 communication bus is 1200m. You can take the following specification as the cabling standard.

<b>Cable length</b>	<b>Specification</b>
< 200m	2*0.3mm <sup>2</sup> , twisted-pair, bushing
200-500m	2*0.5mm <sup>2</sup> , twisted-pair, bushing
500-1200m	2*0.75mm <sup>2</sup> , shielded twisted pair, bushing
> 1200m	2*1.0mm <sup>2</sup> , shielded twisted pair, bushing Add Repeaters at the cable length of 1200m

# 10 Contact

If you have technical problems concerning our products, please contact the Growatt serviceline.

GROWATT NEW ENERGY

Building B, Jiayu Industrial Zone, #28 Guanghui Road, Longteng Community, Shiyan, Baoan District, Shenzhen, P.R.China.

Growatt Serviceline

Tel: +86 755 27471942

E-mail: [service@ginverter.com](mailto:service@ginverter.com)

Web:[www.growatt.com](http://www.growatt.com)